

OWNER'S MANUAL

PORTABLE



P14

HTW-PC-021P14 | HTW-PCS-021P14

Thanks for choosing our product.
Please, read carefully this manual
before using the product

HTW
HIGH TECHNOLOGY WORLD

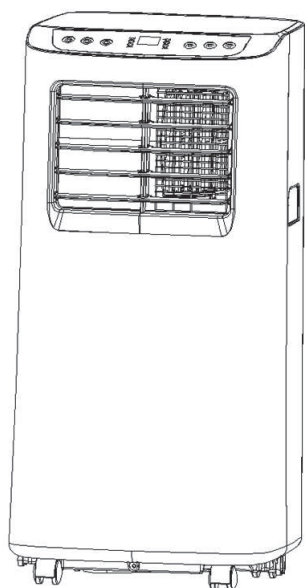

P14 Series

Content

I. Notes	18
II. Features and Components	19
III. Installation and Adjustment	21
IV. Control Setting	23
V. Drainage Instructions	25
VI. Maintenance	26
VII. Troubleshooting	27
VIII. Appendix	28

Thank you for choosing the luxurious and elegant mobile air conditioning. Please keep the manual for later review, and read the manual carefully before use.

Notes

- * The air conditioning is only suitable for indoor use, and is not suitable for other applications.
- * Follow local grid interconnection rules while installing the air conditioning and ensure that it is properly grounded. If you have any question on electrical installation, follow the instructions of the manufacturer, and if necessary, ask a professional electrician to install it.
- * Place the machine in a flat and dry place and keep a distance of above 50cm between the machine and the surrounding objects or walls.
- * After the air conditioning is installed, ensure that the power plug is intact and firmly plugged into the power outlet, and place the power cord orderly to prevent someone from being tripped or pulling out the plug.
- * Do not put any object into the air inlet and outlet of the air conditioning. Keep the air inlet and outlet free from obstructions.
- * When drainage pipes are installed, ensure that the drainage pipes are properly connected, and are not distorted or bended.
- * While adjusting the upper and lower wind-guide strips of the air outlet, pluck it with hands gently to avoid damaging wind-guide strips.
- * When moving the machine, make sure that it is in an upright position.
- * The machine should stay away from gasoline, flammable gas, stoves and other heat sources.
- * Don't disassemble, overhaul and modify the machine arbitrarily, otherwise it will cause a machine malfunction or even bring harm to persons and properties. To avoid danger, if a machine failure occurs, ask the manufacturer or professionals to repair it.
- * Do not install and use the air conditioning in the bathroom or other humid environments.
- * Do not pull the plug to turn off the machine.
- * Do not place cups or other objects on the body to prevent water or other liquids from spilling into the air conditioning.
- * Do not use insecticide sprays or other flammable substances near the air conditioning.
- * Do not wipe or wash the air conditioning with chemical solvents such as gasoline and alcohol. When you need to clean the air conditioning, you must disconnect the power supply, and clean it with a half-wet soft cloth. If the machine is really dirty, scrub with a mild detergent.
- * The appliance can be used by children aged from 8 years and above and persons with reduced physical, sensory or mental capabilities if they have been given supervision or instruction concerning use of the appliance in a safe way and understand the hazards involved. Children shall not play with the appliance. Cleaning and maintenance shall not be made by children without supervision.

Features and Components

1. Features

New look, compact structure, streamlined machine, aristocratic atmosphere.

With cooling,dehumidification and fan function, Continuous Water Drainage Functions.

LED displays the control panel. The machine is beautiful and elegant. High-quality remote control is equipped to facilitate operation. It adopts a user-friendly remote control design.

Outdoor interface is set high to facility assembly and keep the smooth flow of the heat pipe.

Air filtration capability.

Timing switch function.

Protection function of automatically restarting the compressor after three minutes, a variety of other protection functions.

Components

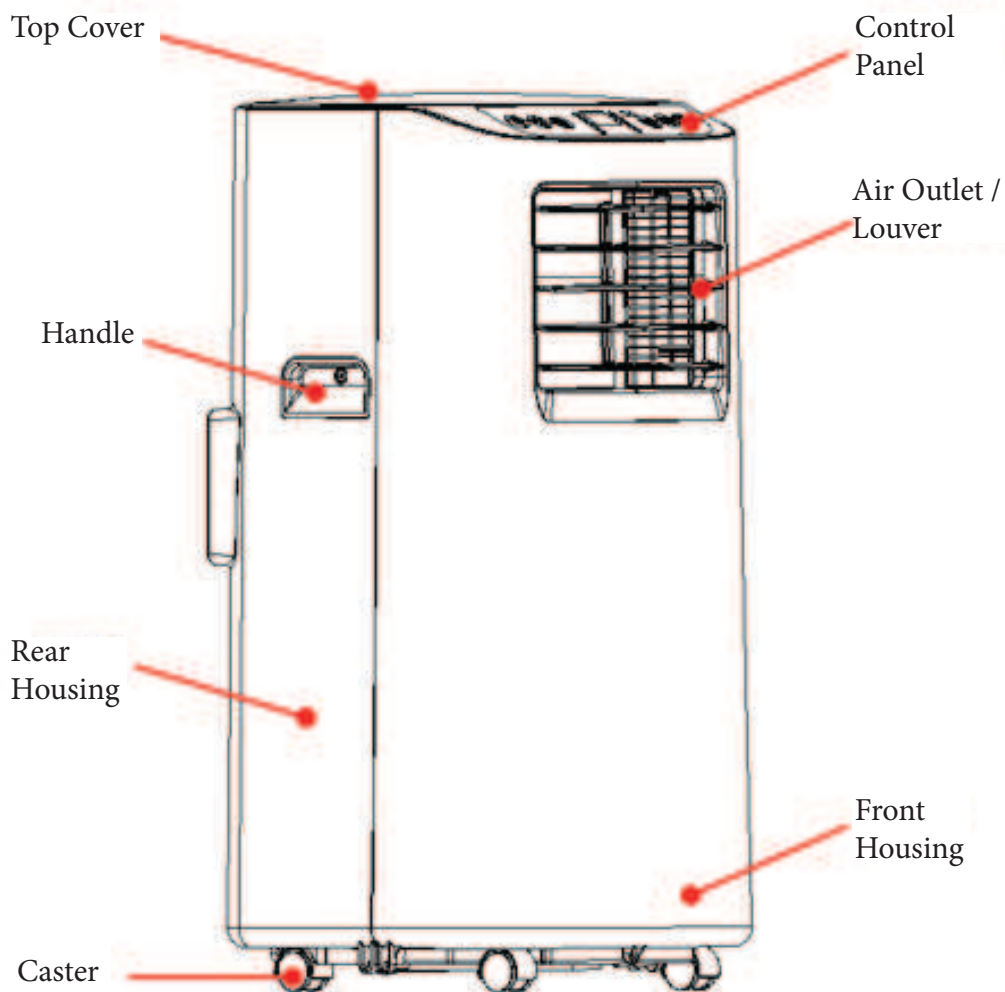

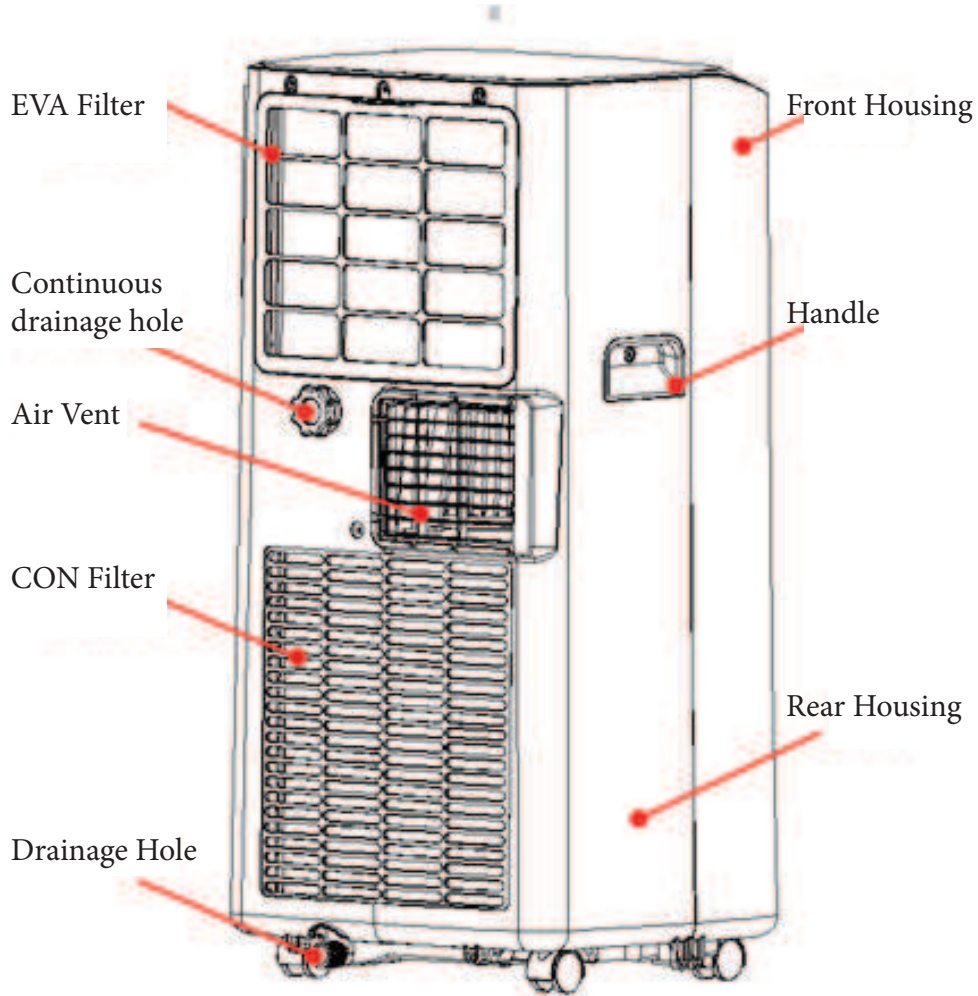

Exhaust Pipe Assembly

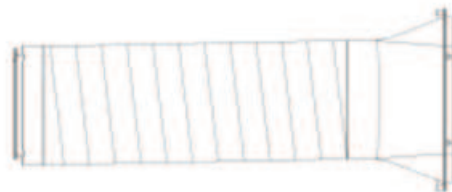

Window Seating Plate Assembly



Installation and Adjustment

1. Installation:

Warning: before using the mobile air conditioning, keep it upright for at least two hours.

The air conditioning can be easily moved in the room. In the moving process, ensure that the air conditioning is in the upright position and the air conditioning should be placed on a flat surface. Do not install and use the air conditioning in the bathroom or other humid environments.

1.1 Install the heat pipe assembly (as shown in Fig.1): screw the heat pipe assembly (exhaust fitting end) into the exhaust port on the rear panel.

1.2 Install the window sealing plate assembly

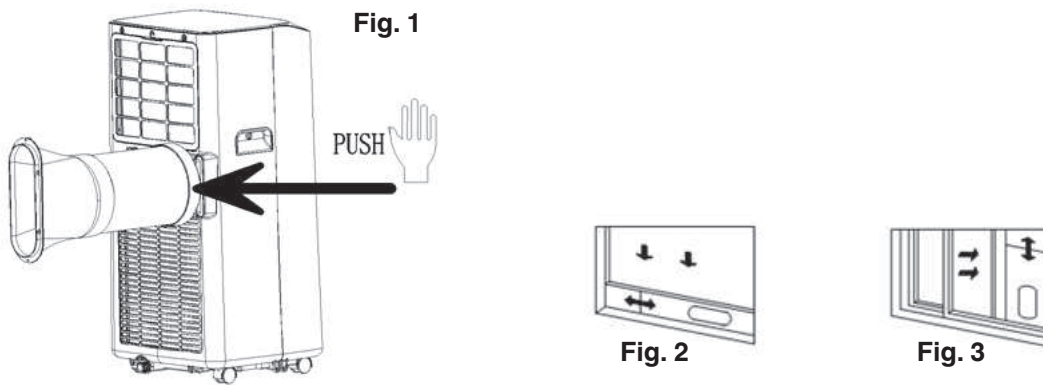

1) Half open the window, and mount the window sealing plate assembly to the window (as shown in Fig.2 and Fig.3); the assembly can be placed in horizontal and vertical direction.

2) Pull various components of the window sealing plate assembly open, adjust their opening distance to bring both ends of the assembly into contact with the window frame, and fix various components of the assembly.

1.3 Install the body

1) Move the machine with installed heat pipe and fittings before the window, and the distance between the body and walls or other objects shall be least 50 cm (as shown in Fig.4).

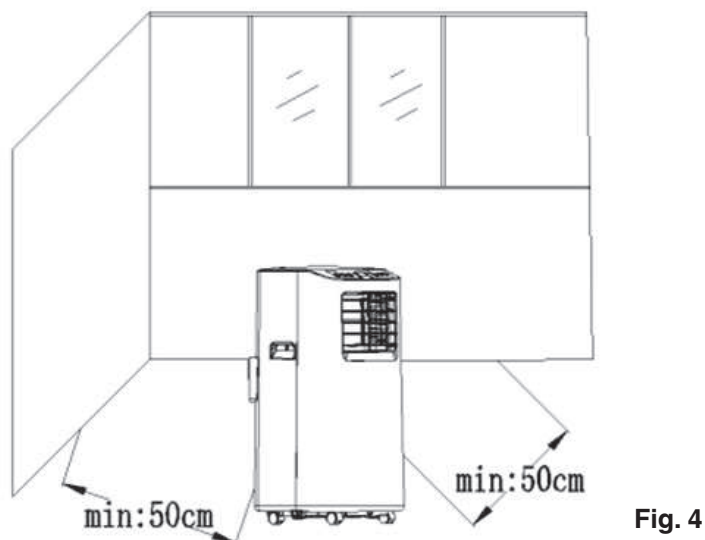

2) Elongate the exhaust pipe and snap the flat end of the exhaust pipe joints into the hole of the window sealing plate assembly (as shown in Fig.5 and Fig.6) .

Notes: 1. the flat end of the exhaust pipe joints must be snapped into place.

2. The pipe cannot be distorted nor has substantial turning (greater than 45 °). Keep the ventilation of the exhaust pipe not blocked.

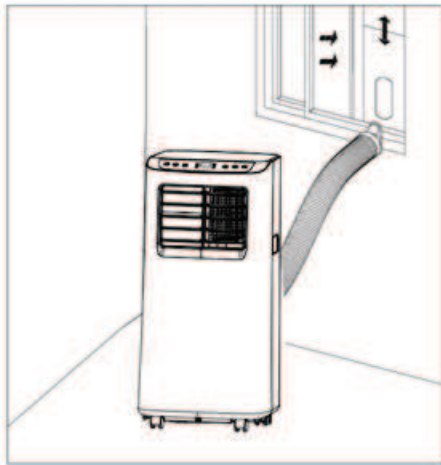

Fig. 5

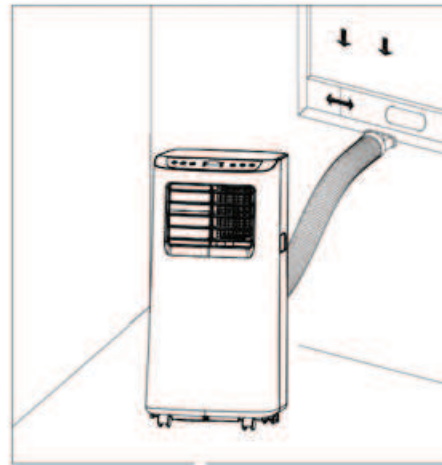

Fig. 6

Important Notice

The length of the exhaust hose shall be 280~1,500mm, and this length is based on the specifications of the air conditioning. Do not use extension tubes or replace it with other different hoses, or this may cause a malfunction. Exhaust host must be not blocked; otherwise it may cause overheating.

Control Panel Setting

I. Operating instructions:

LED Control Panel is as follows:

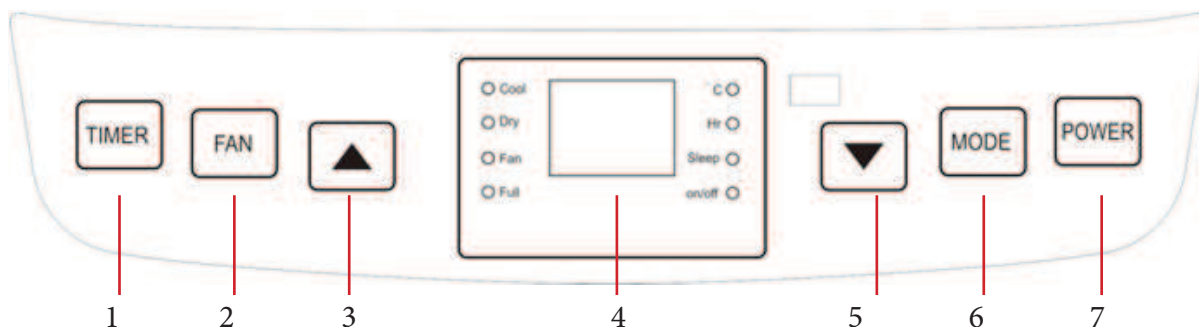

- | | | | |
|--------------|----------------------------|--------------|-------------------|
| 1. Timer Key | 2. Fan Speed Selection Key | 3. Up Key | 4. Display Window |
| 5. Down Key | 6. Mode Selection Key | 7. Power Key | |

1. When the machine is powered on for the first time, the buzzer will play power-on music, and then the machine will get into standby status.

2. Power Key: press the key to turn on and turn off the machine. In the case of power on, press the key to turn off the machine; in the case of power off, press the key to turn on the machine.

3. Mode Selection Key: In the case of power on, press the key to switch between cooling fan dehumidifying mode.

4. Up Key and Down Key: press the two keys to change the setting temperature or setting time, operate as follows:

While setting temperature, press up key or down key to select the required temperature (not available in fan or dehumidifying mode).

While setting time, press up key or down key to select the required time.

5. Wind Speed Selection Key:

In cooling and fan mode, press the key to select high, low wind speed operation. But limited by anti-cold conditions, under certain conditions, it may not run according to the set wind speed.

In dehumidifying mode, pressing the key is invalid, and the fan will forcibly choose low wind speed operation.

6. Timing Key:

In the case of power on, press the key to close timing; in the case of power off, press the key to open timing.

Press the key, when the timing symbol flashes, press up and down key to select the required timing value.

Timing values can be set in 1-24 hours and the timing value is adjusted up or down by one hour.

7. Sleep Mode:

In the cooling Mode, Press the UP and Fan Key to turn on the sleep mode, then the unit will work on Energy-Saving and quiet type.





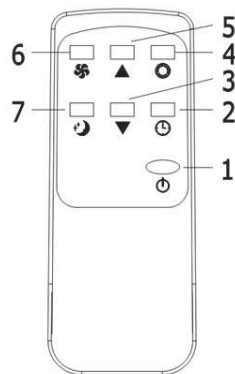

Note: Can not turn on the sleep mode in the dehumidifying or Fan mode!

II. Operating Instructions of the Remote Control

The remote control Panel is as follows:



Instructions of key operation of the high-quality remote control are as follows:

1. **Power:**  Press the key to turn on or turn off the machine.
2. **Timer:**  press the key to set timing.
3. **Down:**  press the key to reduce temperature and timing set value.
4. **Mode:**  press the key to switch between cooling, fan, dehumidifying mode.
5. **Up:**  press the key to increase temperature and timing set value.
6. **Fan:**  press the key to select high, low wind speed.
7. **Sleep Mode:**  Press the key to turn on the sleep mode.

III. A Variety of Protection Functions

3.1 Frost Protection Function:

In cooling, dehumidifying or economic power saving mode, if the temperature of the exhaust pipe is too low, the machine will automatically enter protection status; if the temperature of the exhaust pipe rises to a certain temperature, it can automatically revert to normal operation.

3.2 Overflow Protection Function:

When water in the water pan exceeds the warning level, the machine will automatically sound an alarm, and the “FULL” indicator light will flash. At this point, you need to move the drainage pipe connecting the machine or the water outlet to sewer or other drainage area to empty the water (details see Drainage Instructions at the end of this chapter). After the water is emptied, the machine will automatically return to the original state.

3.3 Automatic Defrosting (cooling models have this function):

The machine has automatic defrosting function.

3.4. Protection Function of the Compressor

To increase the service life of the compressor, it has a 3-minute delay booting protection function after the compressor is turned off.

Drainage Instructions

1. Manual drainage:

1) When the machine stops after the water is full, turn off the machine power and unplug the power plug.

Notes: Please move the machine carefully, so as not to spill the water in the water pan at the bottom of the body.

2) Place the water container below the side water outlet behind the body.

3) Unscrew the drainage cover and unplug the water plug, the water will automatically flow into the water container.

Notes:

1. Keep the drainage cover and the water plug properly.

2. During drainage, the body can be tilted slightly backwards.

3. If the water container cannot hold all the water, before the water container is full, stuff the water outlet with the water plug as soon as possible to prevent water from flowing to the floor or the carpet.

4) When the water is discharged, stuff the water plug, and tighten the drainage cover.

Notes: 1. Restart the machine after the water plug and drainage cover are installed, otherwise condensate water of the machine will flow to the floor or the carpet.

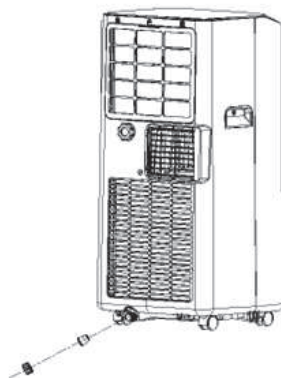

2. Continuous drainage (Optional) (only applicable to cooling and dehumidifying mode), as shown in figure:

1) Unscrew the drainage cover, and unplug the water plug.

2) Set the drainage pipe into the water outlet.

3) Connect the drainage pipe to the bucket.

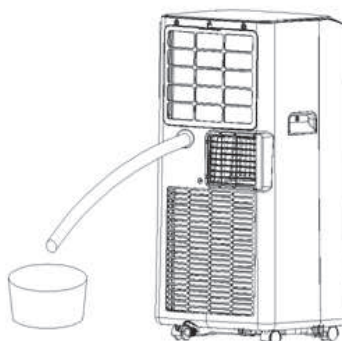

Maintenance

Cleaning: before cleaning and maintenance, turn off the machine and unplug the plug.

1. Clean the surface

Clean with surface of machine with a wet soft cloth. Don't use chemicals, such as benzene, alcohol, gasoline, etc.; otherwise, the surface of the air conditioning will be damaged or even the whole machine will be damaged.

2. Clean the filter screen

If the filter screen is clogged with dust, and the effectiveness of the air conditioning is reduced, be sure to clean the filter screen once every two weeks.

2.1 Clean the upper filter screen frame

1) Clasp the wedging block of the EVA filter screen frame with hands. Force down from the outside to remove the EVA filter screen frame. Unscrew four screws fixing the EVA filter screen and the rear housing to remove the EVA filter screen (as shown in the above figure) .

2) Put the EVA filter screen into warm water with neutral detergent (about 40 / 104) and dry it in the shade after rinsing clean.

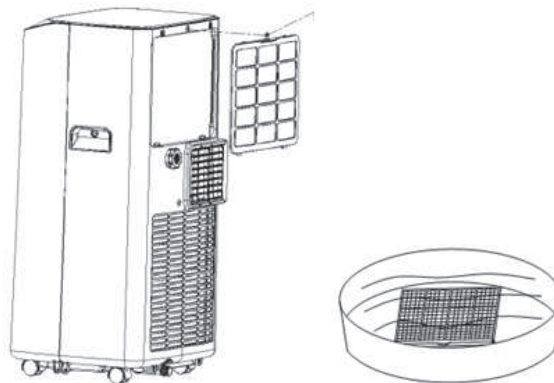

Unit Storage:

1. Unscrew the drainage cover, unplug the water plug, and discharge the water in the water pan into other water containers or directly tilt the body to discharge the water into other containers.

2. Turn on the machine, adjust it to low-wind ventilation mode, and maintain this state until the drainage pipe becomes dry, so as to keep the inside of the body in a dry state and prevent it from mildewing.

3. Turn off the machine, unplug the power plug, and wrap the power cord around the wrapping post; install the water plug and the drainage cover.

4. Remove the exhaust pipe and keep it properly.

5. Cover the air conditioning with a plastic bag. Put the air conditioning in a dry place, keep it out of the reach of children, and take dust control measures.

6. Remove batteries of the remote control and keep them properly.

Note: ensure that the body is placed in a dry place and keep all machine components properly.

Troubleshooting

Do not repair or disassemble the air conditioning by yourself. Unqualified repair will lead to failure of the warranty card, and may cause damage to users or their properties.

Problems	Reasons	Solutions
The air conditioning does not work.	There is no electricity.	Turn it on after connecting it to a socket with electricity.
	The overflow indicator displays "FL".	Discharge the water inside.
	The ambient temperature is too low or too high	Recommend to use the machine in at the temperature of 7-35°C (44-95°F).
	In cooling mode, the room temperature is lower than the set temperature; in heating mode, the room temperature is higher than the set temperature.	Change the set temperature.
	In dehumidification mode, the ambient temperature is low.	The machine is placed in a room with an ambient temperature of greater than 17°C (62°F).
The cooling effect is not good	There is direct sunlight.	Pull the Curtain.
	Doors or windows are open; there are a lot of people; or in cooling mode, there are other sources of heat.	Close doors and windows, and add new air conditioning.
	The filter screen is dirty.	Clean or replace the filter screen.
	The air inlet or outlet is blocked.	Clear obstructions.
Big Noise	The air conditioning is not placed on a flat surface.	Put the air conditioning on a flat and hard place (to reduce noise).
compressor does not work.	Overheat protection starts.	Wait for 3 minutes until the temperature is lowered, and then restart the machine.
The remote control does not work.	The distance between the machine and the remote control is too far.	Let the remote control get close to the air conditioning, and make sure that the remote control directly faces to the direction of the remote control receiver.
	The remote control is not aligned with the direction of the remote control receiver.	
	Batteries are dead.	Replace batteries.
Displays 'E1'.	The pipe temperature sensor is abnormal.	Check the pipe temperature sensor and related circuitry.
Displays 'E2'	The room temperature sensor is abnormal.	Check the room temperature sensor and related circuitry.

Note: If problems not listed in the table occur or recommended solutions do not work, please contact the professional service organization.

Appendix

Fuse Parameters

Type: FSD or 50F

Voltage: 250V

Current: 3.15A

Schematic diagram

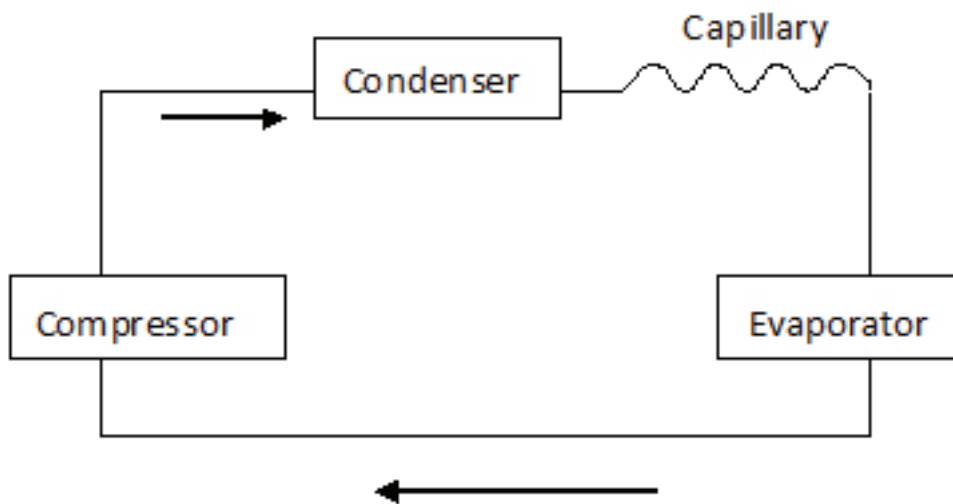

All the technical and specific parameters, please refer to product nameplate.

Due to continuous improvement, we reserve the right to change some design without any notice.

Treatment: Don't put the abandoned machine with other unsorted waste together. Such waste shall be placed separately for other special use.

